

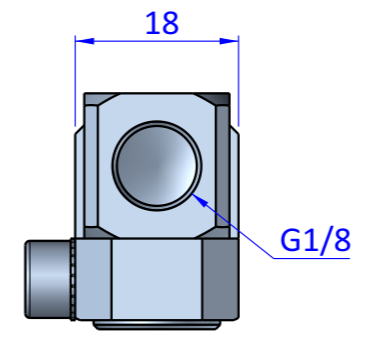

THE PROPERTY OF THE DRAWING IS ESTABLISHED BY LAW. IT IS FORBIDDEN TO PRODUCE OR SHOW IT TO THIRD PART. WITHOUT A WRITTEN AGREEMENT.

Item	Name	Q.ty
1	GGB.14.18.18	1
2	GGB.14.120	1
3	R.5.SCH	1
4	V.TCE5x18	1

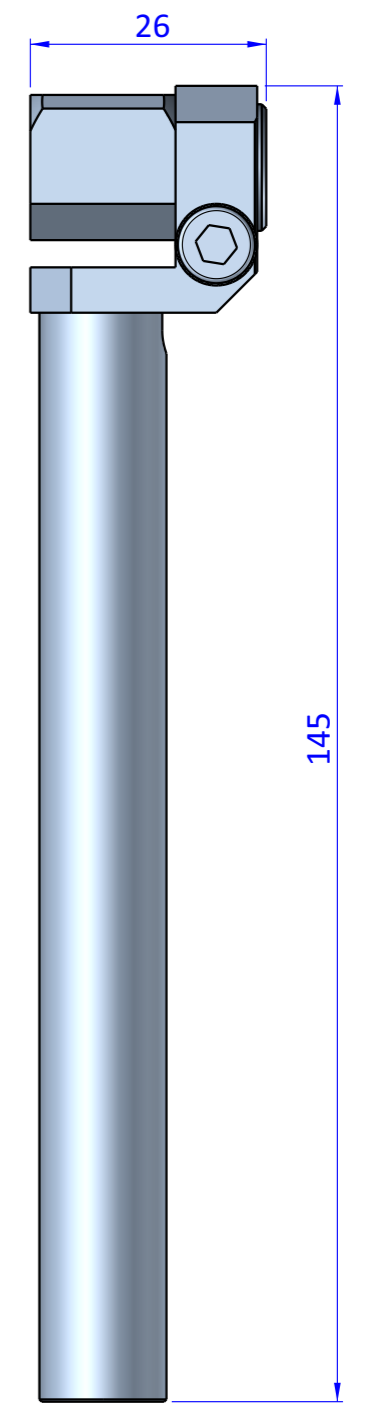
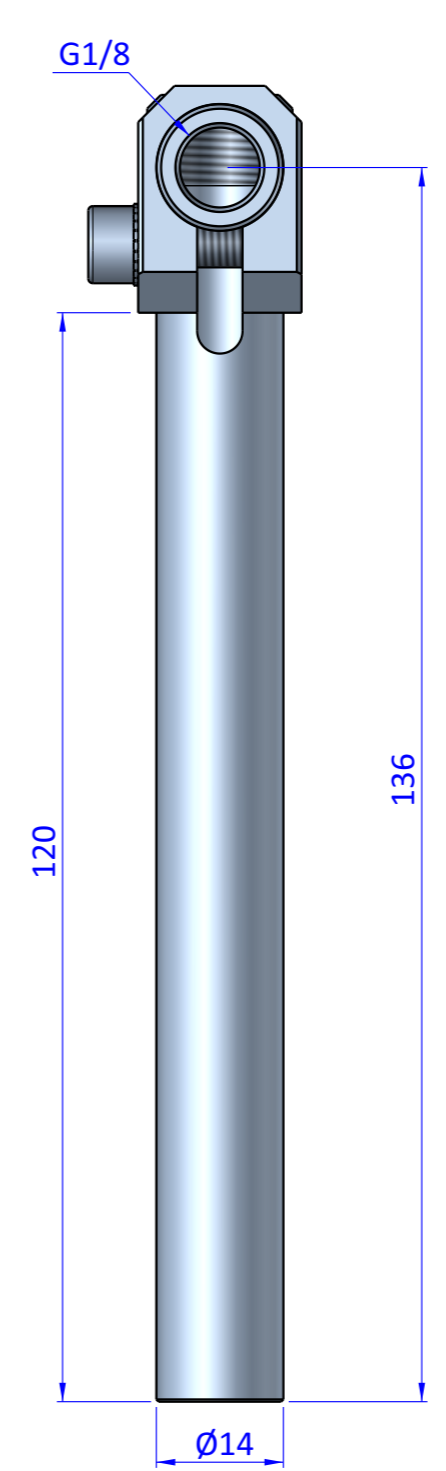
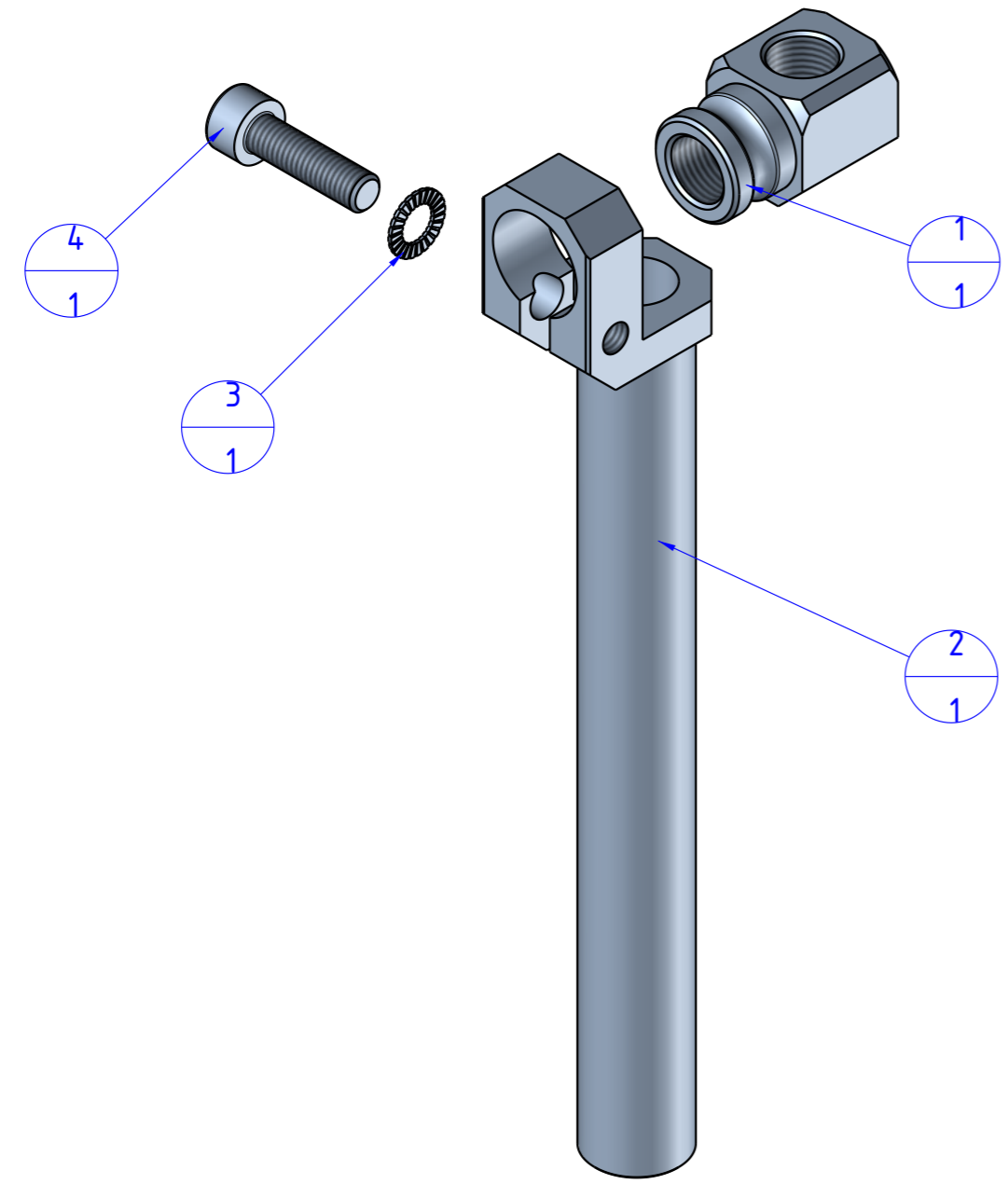

Format A3
UNI 936-76

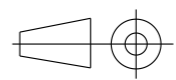
 FPS FPSERVICES AUTOMATION			DESIGNED FROM FPS Automation	REVIEW A
GENERAL TOLERANCE UNI - ISO 2768 CLASSE f	DESCRIPTION CA.GGB.141818120	DATE 06/08/2020	WEIGHT 0,046kg	CODE CA.GGB.141818120